

# A5 MAGAZINE - PERFECT or BURST BOUND SIZE: 210mm x 148mm

TRIM SIZE: 210mm x 148mm
  BLEED: 218mm x 156mm
  SAFE PRINT AREA: 200mm x 138mm
 ..... INK FREE ZONE

SPINE WIDTH

This will vary depending on the number of text pages and your selected stock option.

To calculate spine width [CLICK HERE](#).

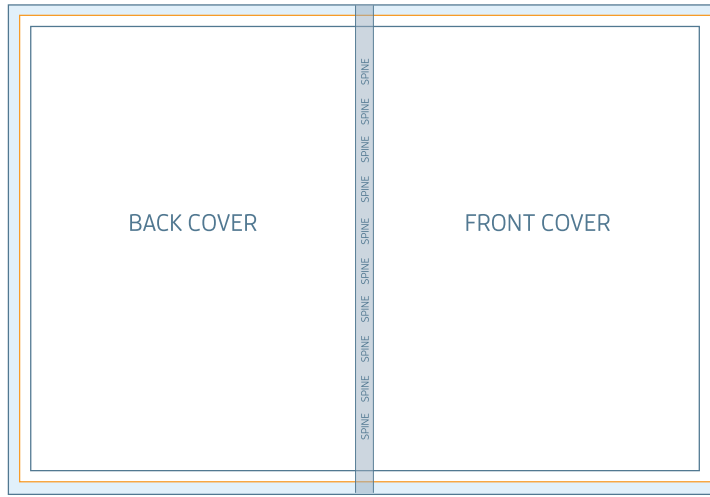

INK FREE ZONE - Inside Covers   
(indicated by dotted orange lines)

On the inside covers, due to adhesion requirements, the booklet spine plus 3mm on each side of the spine must be kept ink free.

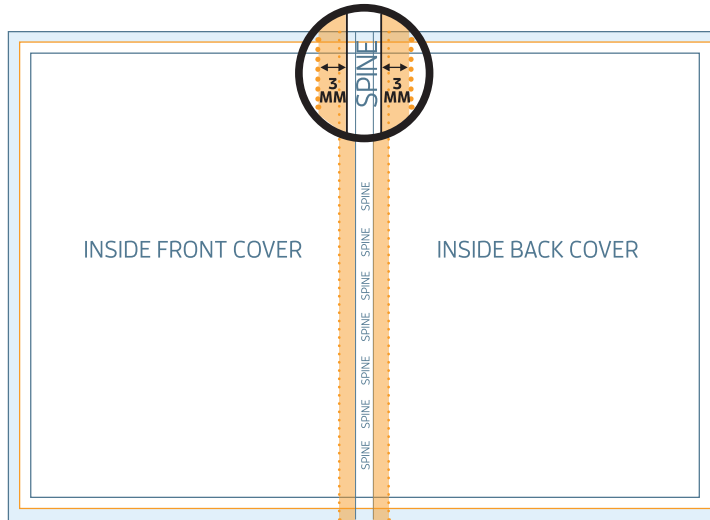

INK FREE ZONE - Text Pages   
(indicated by dotted orange lines)

On the first and last text pages, due to adhesion requirements, a 3mm strip next to the spine must be kept free of all ink.

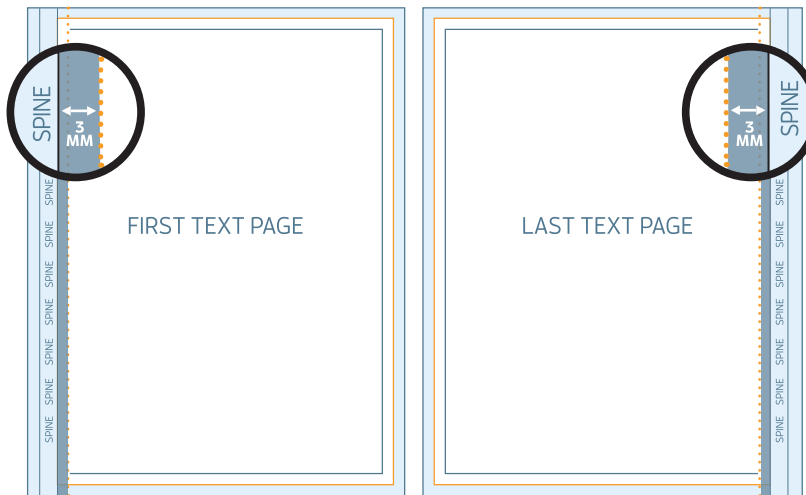

TEXT AND LOGO LINE UP   
(indicated by dotted blue line)

For line up between the inside front cover and page 1 and/or inside back cover and the last page, the line up point will be 7mm in from the spine. (ie at the hinge score)

4mm bleed is the maximum allowed, from this score. (ie up to the ink free zone)

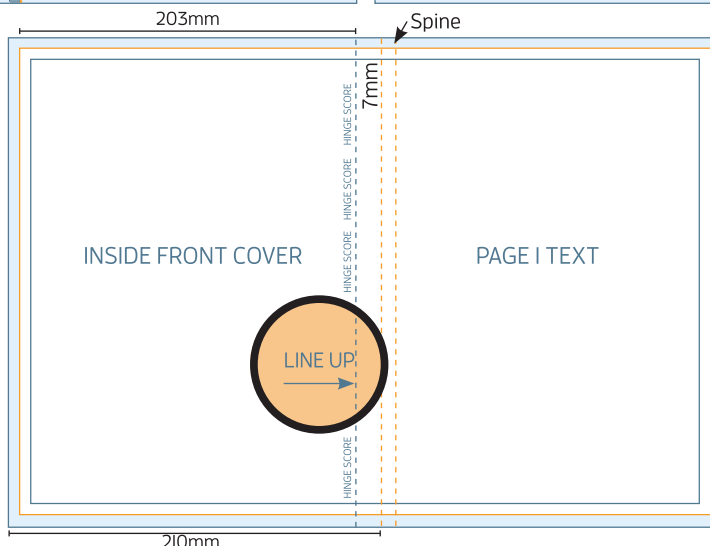

# PERFECT or BURST BOUND BOOKS

## ARTWORK SET UP - A5 PORTRAIT

- 1 The spine width will vary depending on the number of text pages and selected stock option.  
To calculate the spine width [click here](#).
- 2 The spine width must be included in the cover spread. I.e. If the spine width is 5mm for a A5 portrait book, the cover will be calculated as follows:

$$210\text{mm} \times 297\text{mm} (+ 5\text{mm spine}) = 210\text{mm} \times 302\text{mm new cover spread}$$

- 3 The inner cover spread includes a spine and hinge area. **NO ink** is allowed for the following:

- Spine width (this will vary depending on book size)
- 3mm glue trap/ink free zone (note that the first 3mm of the 7mm hinge is the glue trap/ink free zone)

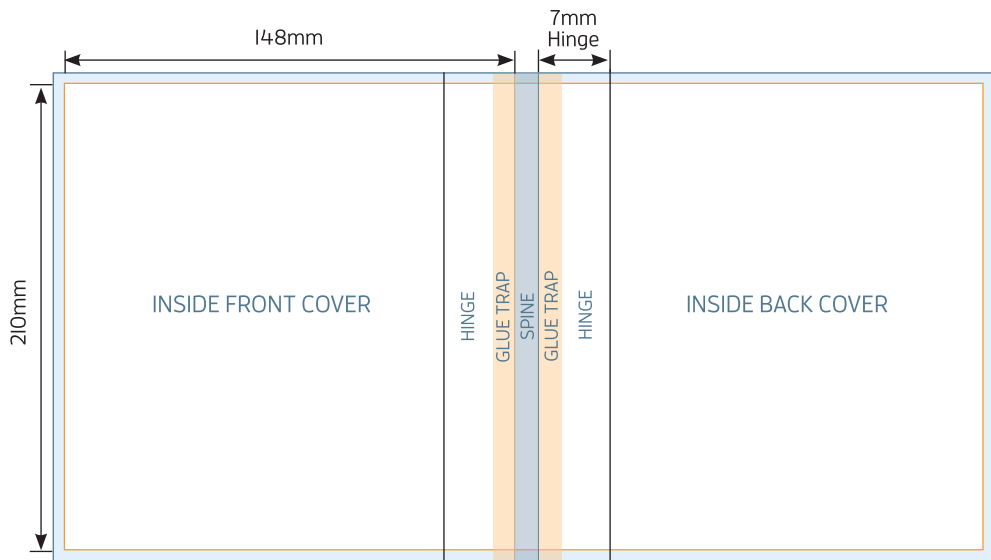

\*\*\*Shaded area is no ink zone - spine width + 3mm both sides\*\*\*

Therefore, no print is allowed beyond 145mm from cut edge for a portrait A4 booklet to allow for the 3mm glue ink free zone.

When working with covers where line up is crucial with text pages, please take into consideration that the line up point is 7mm in from the spine. Due to the processes involved in binding, there will always be some movement and will not always be exact.

# A5 MAGAZINE - PERFECT or BURST BOUND

SIZE: 210mm x 148mm

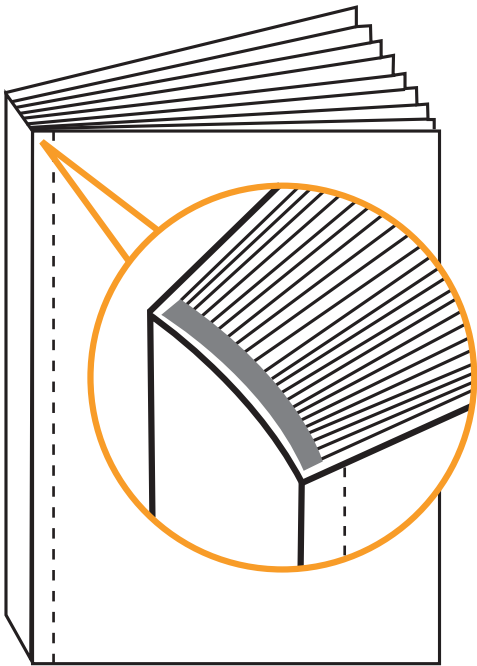

SECTIONS (text pages)

Cover Stock

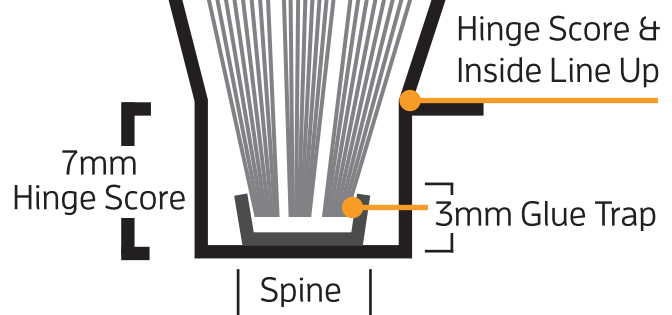

7mm  
Hinge Score

| Spine |

Hinge Score &  
Inside Line Up

3mm  
Glue Trap